

## MMBT3906-HF (PNP)

RoHS Device  
Halogen Free



### Features

- Epitaxial planar die construction
- As complementary type, the NPN transistor MMBT3906-HF is recommended

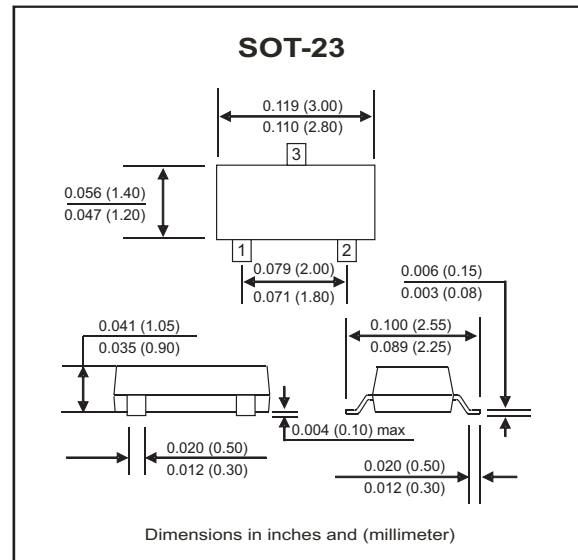
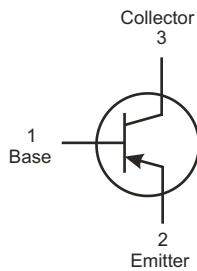

### Maximum Ratings (at TA=25°C unless otherwise noted)

Parameter	Symbol	Min	Typ	Max	Unit
Collector-Base voltage	V <sub>CB0</sub>			-40	V
Collector-Emitter voltage	V <sub>CE0</sub>			-40	V
Emitter-Base voltage	V <sub>EBO</sub>			-5	V
Collector current-Continuous	I <sub>c</sub>			-0.2	A
Collector dissipation	P <sub>c</sub>			0.3	W
Storage temperature and junction temperature	T <sub>STG</sub> , T <sub>J</sub>	-55		+150	°C

### Electrical Characteristics (at TA=25°C unless otherwise noted)

Parameter	Conditions	Symbol	Min	Max	Unit
Collector-Base breakdown voltage	I <sub>c</sub> = -100μA , I <sub>E</sub> = 0	V <sub>(BR)CB0</sub>	-40		V
Collector-Emitter breakdown voltage	I <sub>c</sub> = -1mA , I <sub>B</sub> = 0	V <sub>(BR)CE0</sub>	-40		V
Emitter-Base breakdown voltage	I <sub>E</sub> = -100μA , I <sub>c</sub> = 0	V <sub>(BR)EBO</sub>	-5		V
Collector cut-off current	V <sub>CB</sub> = -40V , I <sub>E</sub> = 0	I <sub>cBO</sub>		-0.1	μA
Collector cut-off current	V <sub>CE</sub> = -40V , I <sub>B</sub> = 0	I <sub>CE0</sub>		-0.1	μA
Emitter cut-off current	V <sub>EB</sub> = -5V , I <sub>c</sub> = 0	I <sub>EBO</sub>		-0.1	μA
DC current gain	V <sub>CE</sub> = -1V , I <sub>c</sub> = -10mA	h <sub>FE(1)</sub>	100	300	
	V <sub>CE</sub> = -1V , I <sub>c</sub> = -50mA	h <sub>FE(2)</sub>	60		
Collector-Emitter saturation voltage	I <sub>c</sub> = -50mA , I <sub>B</sub> = -5mA	V <sub>CE(sat)</sub>		-0.3	V
Base-Emitter saturation voltage	I <sub>c</sub> = -50mA , I <sub>B</sub> = -5mA	V <sub>BE(sat)</sub>		-0.95	V
Transition frequency	V <sub>CE</sub> = -20V , I <sub>c</sub> = -10mA f = 100MHz	f <sub>T</sub>	250		Mhz
Delay time	V <sub>CC</sub> = -3.0V , V <sub>BE</sub> = -0.5V	t <sub>d</sub>		35	nS
Rise time	I <sub>c</sub> = -10mA , I <sub>B1</sub> = -1.0mA	t <sub>r</sub>		35	nS
Storage time	V <sub>CC</sub> = -3.0V <sub>dc</sub> , I <sub>c</sub> = -10mA	t <sub>s</sub>		225	nS
Fall time	I <sub>B1</sub> = I <sub>B2</sub> = -1.0mA	t <sub>f</sub>		75	nS

## RATING AND CHARACTERISTIC CURVES (MMBT3906-HF)

Fig.1- Static Characteristic

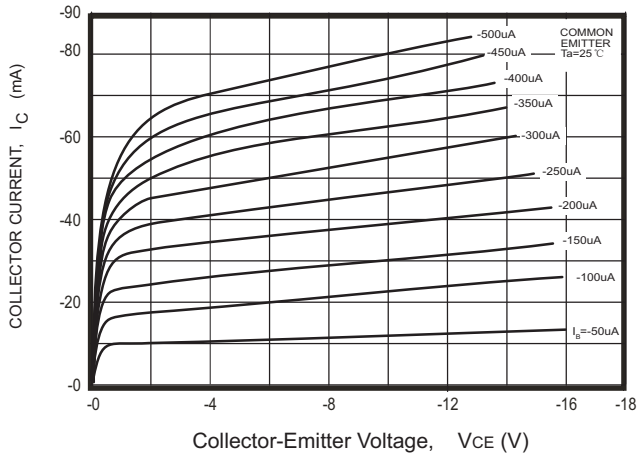

Fig.2-  $h_{FE} - I_C$

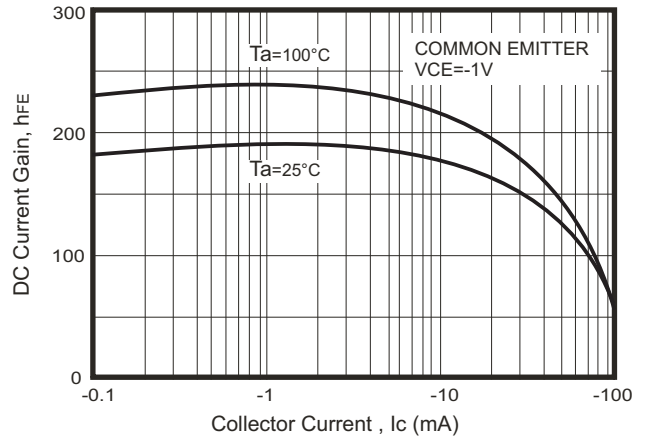

Fig. 3-  $V_{CEsat} - I_C$

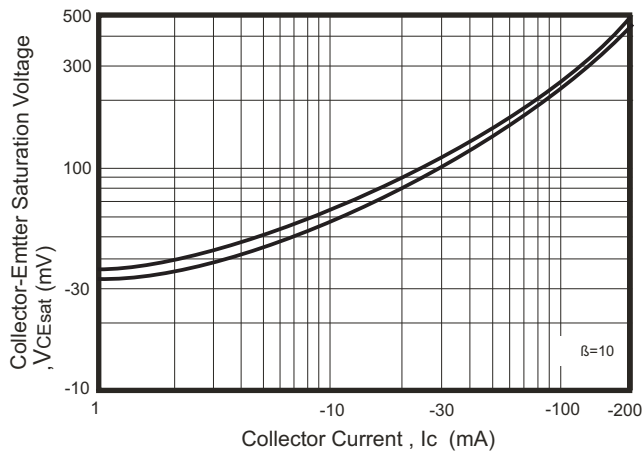

Fig. 4-  $V_{BEsat} - I_C$

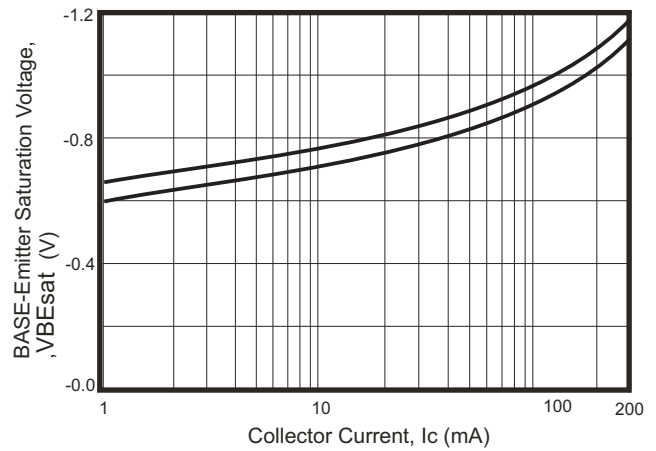

Fig. 5-  $I_C - V_{BE}$

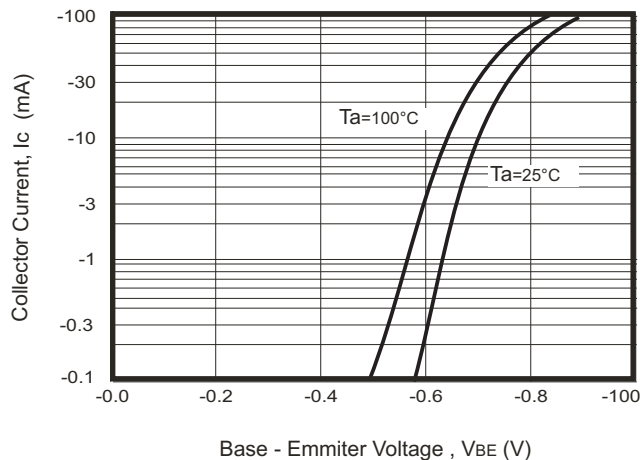
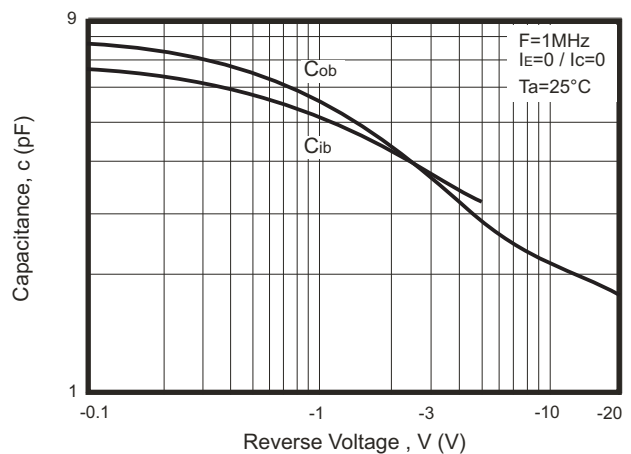

Fig. 6-  $C_{ob}/C_{ib} - V_{CB}/V_{EB}$



## RATING AND CHARACTERISTIC CURVES (MMBT3906-HF)

Fig. 7-  $f_r - I_c$

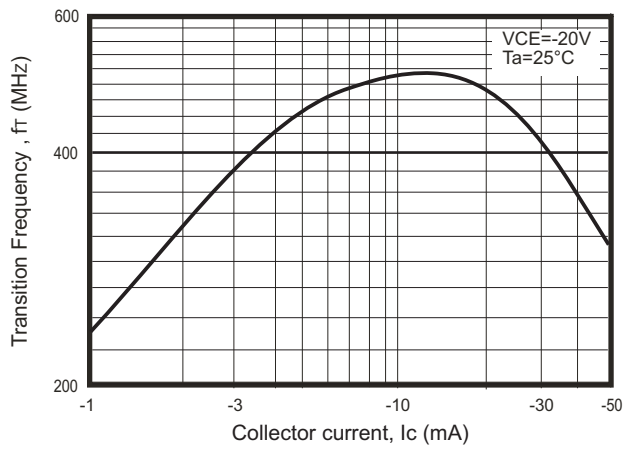
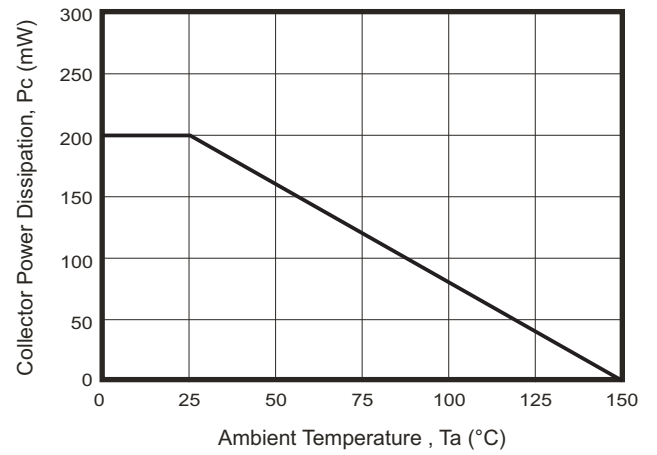
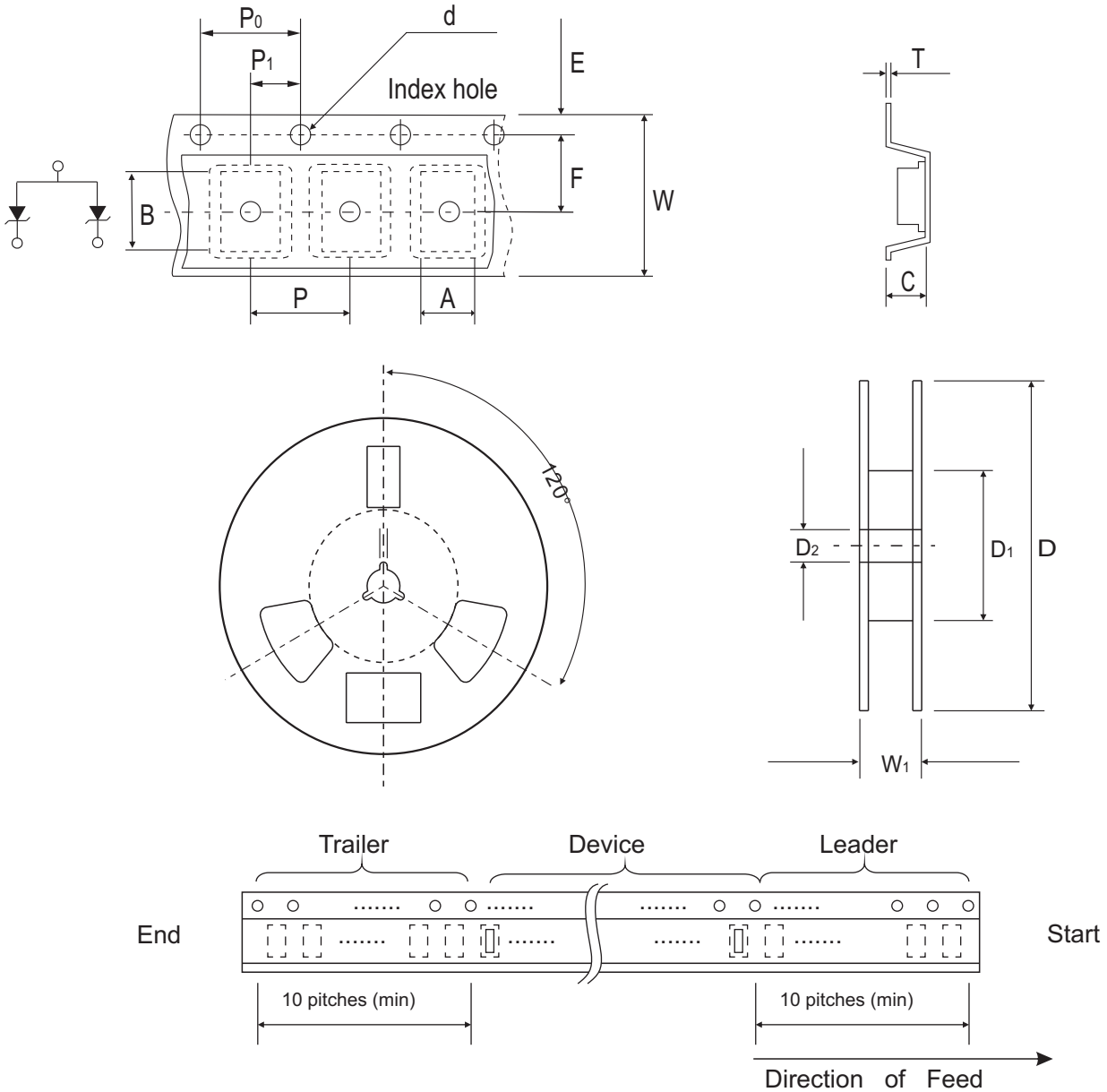

Fig. 8-  $P_c - T_a$



## Reel Taping Specification



SOT-23	SYMBOL	A	B	C	d	D	D <sub>1</sub>	D <sub>2</sub>
	(mm)	$3.15 \pm 0.10$	$2.77 \pm 0.10$	$1.22 \pm 0.10$	$1.50 \pm 0.10$	$178 \pm 1.00$	$54.40 \pm 0.40$	$13.00 \pm 0.20$
	(inch)	$0.124 \pm 0.004$	$0.109 \pm 0.004$	$0.048 \pm 0.004$	$0.059 \pm 0.004$	$7.008 \pm 0.039$	$2.142 \pm 0.016$	$0.512 \pm 0.008$

SOT-23	SYMBOL	E	F	P	P <sub>0</sub>	P <sub>1</sub>	W	W <sub>1</sub>
	(mm)	$1.75 \pm 0.10$	$3.50 \pm 0.05$	$4.00 \pm 0.10$	$4.00 \pm 0.10$	$2.00 \pm 0.10$	$8.00 \pm 0.30 / - 0.10$	$9.50 \pm 1.00$
	(inch)	$0.069 \pm 0.004$	$0.138 \pm 0.002$	$0.157 \pm 0.004$	$0.157 \pm 0.004$	$0.079 \pm 0.004$	$0.315 \pm 0.012 / - 0.004$	$0.374 \pm 0.039$

## Marking Code

Code: Per A. D.

Part Number	Marking Code
MMBT3906-HF	2A

Year(Even)-Month	Code	Year(Even)-Month	Code
XXX1-01	J	XXX2-01	W
XXX1-02	O	XXX2-02	N
XXX1-03	L	XXX2-03	Y
XXX1-04	C	XXX2-04	T
XXX1-05	K	XXX2-05	R
XXX1-06	B	XXX2-06	H
XXX1-07	P	XXX2-07	A
XXX1-08	D	XXX2-08	I
XXX1-09	M	XXX2-09	U
XXX1-010	E	XXX2-010	X
XXX1-011	G	XXX2-011	Z
XXX1-012	F	XXX2-012	S

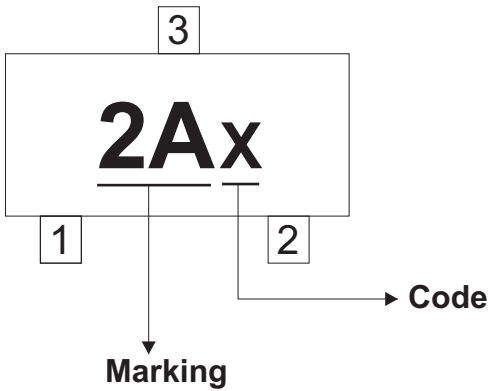

## Suggested PAD Layout

SIZE	SOT-23	
	(mm)	(inch)
A	0.80	0.031
B	1.90	0.075
C	2.02	0.080
D	2.82	0.111

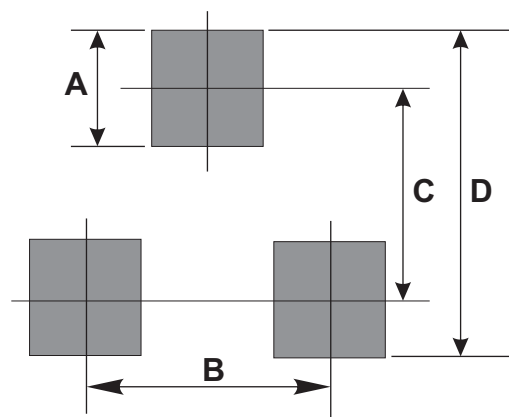

## Standard Packaging

Case Type	Qty per Reel	Reel Size
	(Pcs)	(inch)
SOT-23	3000	7